

GROUND FRAME™

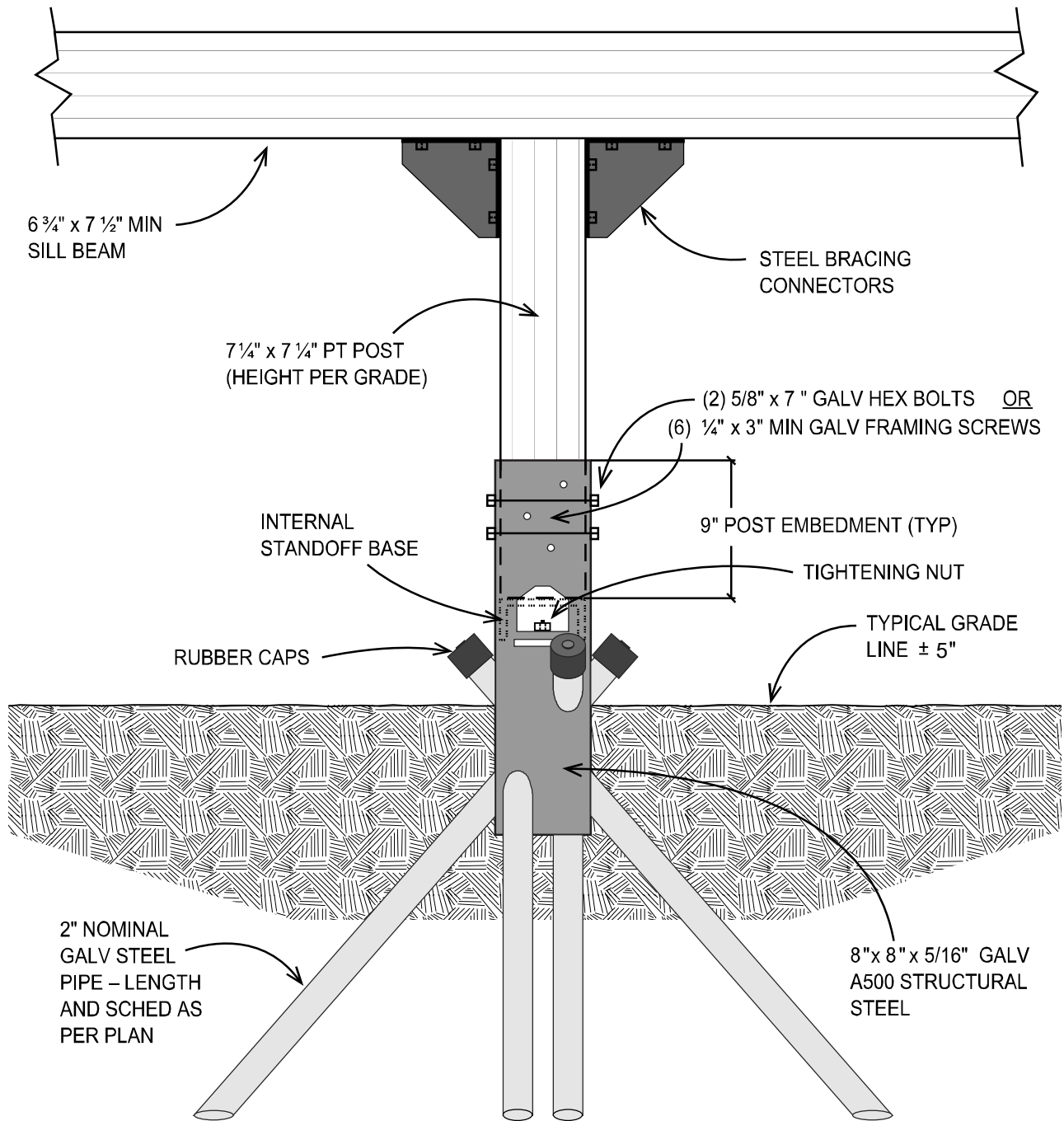

GROUND FRAME COLUMN – MODEL GFC-200

U.S. Patents 8,714,881; 11,078,641; 11,091,894 & pat pending

© 2023 Pin Foundations, Inc. All Rights Reserved.

CTS1020/07.23

GroundFrames.com
info@groundframes.com
253-858-8809

Pin Foundations, Inc.
4810 Pt Fosdick Dr NW, PMB 60
Gig Harbor, Washington 98335